

English

OWNER'S MANUAL

Air motors



PRESENTATION OF MANUAL

INSTRUCTIONS FOR USE

Technical Name: Dental Hand Instruments

Trade Name: Dental Hand Instrument for Low Speed

Models:

- MICRO MOTOR INTRA 32 MM - C SPRAY TB
- MICRO MOTOR INTRA 32 MM - C SPRAY TM
- MICRO MOTOR INTRA 32 MM - S SPRAY TB
- MICRO MOTOR INTRA SL 30 - C SPRAY TB
- MICRO MOTOR INTRA SL 30 - C SPRAY TM
- MICRO MOTOR INTRA SL 30 - S SPRAY TB
- MICRO MOTOR INTRA SL 30 TB SI
- MICRO MOTOR INTRA SL 30 TM SI

Brand: D700

Manufacturer/ Distributor:

Alliage S/A Indústrias Médico Odontológica

C.N.P.J. 55.979.736/0001-45 - Insc. Est. 582.002.897.114

Rod. Abrão Assed, Km 53+450m - Cx. Postal 782 CEP 14097-500

Ribeirão Preto - S.P. - Brasil

Telefone +55 (16) 3512-1212

Technical Duties: Daniel R. de Camargo

CREA-SP: 5062199650

Registro ANVISA nº: 10069210073

ATTENTION

For greater safety:

Read and understand all the instructions contained in these instructions for use before installing or operating this equipment.

Note: These instructions for use must be read by all the operators of this equipment.

INDEX

02 PRESENTATION OF MANUAL

04 IDENTIFICATION OF EQUIPMENT

04 Indication of Use

04 Contraindication

05 DESCRIPTION OF EQUIPMENT

05 General description

05 Application specification

05 Operation principle

05 Significant physical characteristics

05 User profile

06 Models

07 Sets and Parts

08 TECHNICAL SPECIFICATIONS

08 General features

08 Abbreviations

09 Packing symbols

09 Product symbols

10 Dimensions

11 OPERATION OF EQUIPMENT

12 PRECAUTIONS, RESTRICTIONS AND WARNINGS

12 Recommendations for preserving the equipment

12 Transportation, storage and operation

12 Sensibility to predictable environmental conditions in regular use conditions

12 Precautions and warnings “during the use” of equipment

13 Precautions and warnings “after” the use of equipment

13 Precautions in case of alteration in the functioning of equipment

13 Precautions to be adopted against foreseeable or uncommon risks, related to the deactivation and abandoning of equipment

13 Environmental impact reduction precautions

14 EQUIPMENT REUSE

14 Additional procedures for reuse

14 Cleaning and Disinfection

14 Sterilization

15 Lubrication in spray

16 INSPECTION AND MAINTENANCE

16 Periodic Inspection

16 Preventive Maintenance

16 Corrective Maintenance

17 Maintenance of the BORDEN Type Lining

17 Spray Regulation

17 Maintenance of the MIDWEST Type Lining

18 Maintenance of O-Ring

19 EQUIPMENT'S WARRANTY

19 FINAL CONSIDERATIONS

IDENTIFICATION OF EQUIPMENT

Dear Customer

This manual is a general presentation of your product and it will give you important details to help you to solve possible problems.

Please, read it and keep this with you.



Indication of Use

The Alliage handpieces are intended to remove caries, remove restorations and perform tooth sectioning, as an aid in extracting teeth, and they are for exclusive dental use, and must be handled by trained, qualified and regulated health professionals according to local legislation.

Contraindication

None known.

DESCRIPTION OF EQUIPMENT

General Description

Compact handpiece, ergonomic design, body made of metal with surface treatment. Rotor supported on bearings providing a low noise level, speed adjustment in clockwise and counterclockwise directions, adapts to any contra angle or straight piece handpiece in the INTRA system.

The Alliage handpieces have been planned to offer maximum performance in the most severe clinical procedures. With a design which caters for ergonomics, torque, sensitivity and lightness. Produced with technology (MADE IN BRAZIL) and material of the utmost durability.

Internal irrigation System (according to model acquired): without the need for adaptations, the internal irrigation system allows direct passage of water flow to the counter angle or straight piece with the power required for the formation of the spray.

To ensure safe operation of your equipment, use only the mounting assembly (chair, equip, water unit and reflector) provided by Alliage Authorized Reseller Service.

Application specification

Alliage Dental Handpieces are designed to perform most routine dental procedures in intraoral region treatments.

Operation principle

The Air motors operates by pneumatic pressure and has an Intra connection system to be used with Low Speed Dental Handpieces.

Significant physical characteristics

The Air motors promotes shaft revolutions in the magnitude of 5,000 to 20,000 revolutions/minute and has a torque of 0.350 - 1,000 N.cm. Under normal operating conditions, the equipment has a compressed air consumption of 54 L/min and a water consumption of 42 mL/min.

User profile

Alliage Dental Handpieces can be operated and handled by users of both sexes, with the ability to read and understand images, symbols, icons, western Arabic characters (Arial font), alpha numeric characters, knowing how to distinguish intraoral part of the human body, not being able to present a degree of visual imperfection for reading or seeing and an average degree of impairment of recent memory, not being in a clear capacity to perform the activities and functions of the product in a correct manner to the profession.

The user needs to be a qualified health professional and trained with technical competence in the health and dentistry field.

DESCRIPTION OF EQUIPMENT

Models



Attention

The contents of this page are of an informative nature, the equipment being able to differ from that illustrated. So, upon acquiring the product check the technical compatibility between equipment, coupling and accessories.



External Spray Irrigation System

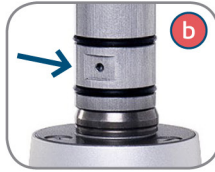

Internal Spray Irrigation System



* Available in BORDEN and MIDWEST versions

01 - Micromotor Intra SL 30 - C Spray TB / TM.

02 - Micromotor Intra SL 30 - S Spray TB; Micromotor Intra 32 MM - S Spray TB.

03 - Micromotor Intra 32 MM - C Spray TB / TM; Micromotor Intra SL 30 TB SI; Micromotor Intra SL 30 TM SI.

c - Control ring



Terminal type
*BORDEN



Terminal type
*MIDWEST

* Optional

DESCRIPTION OF EQUIPMENT

Sets and Parts

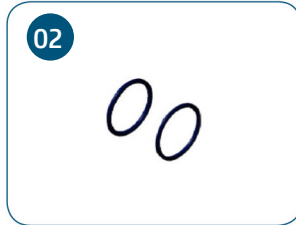

Attention

-The use of any part, accessory or material not specified or foreseen in these instructions for use is entirely the user's responsibility.

01 - Coupling lining (TB/TM)

02 - O-ring

*03 - Lubricant Lubs

TECHNICAL SPECIFICATIONS

General features

Air and water working pressure (Recommended)

Air: Maximum 275,79 kpa = 40 psi = 2,75 bar
Water: Minimum = 28.15mH₂O (Water column meters)

Air and water consumption

Air: 54 l/min
Water: 42 ml/min

Rotation

From 5,000 to 20,000 r/min

Fitting terminal

Borden Type 02 holes
Midwest Type 04 holes

Coupling

via the INTRA system
Straight Piece and Contra Angle

Sterilization

Autoclavable up to 135°C

Coupling type

Type 2 (According to ISO 3964)

Length X1

Long type - max. 31,8mm (According to ISO 3964)

Torque

0,350 - 1,000 N.cm.

Weights

Model	Net Weight	Gross Weight
32 MM	77g	137g
SL 30	80g	140g

ABBREVIATIONS

MM - Air motors
S - Spray
C Spray - With Spray
S Spray - Without Spray
SI - Internal Spray
TM - Midwest type
TB - Borden type

TECHNICAL SPECIFICATIONS

Packing symbols



Stacking limit by number



Keep dry



This side Up



Keep out of sunlight



Fragile, handle with care

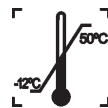

Temperature limitation

Product symbols



Sterilizable in a steam sterilizer (autoclave) at the specified temperature



Recyclable



General warning



Indicates that the product must be taken to a special waste collection site at the end of its useful life.



Attention



Manufacturer



Serial number



Model number



Manufacturing date



To indicate a reference to spraying liquid



Instructions for use



Borden Type Terminal

TECHNICAL SPECIFICATIONS



Midwest Type Terminal

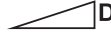

Variability to the right

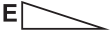

Variability to the left



Model



Lot

Dimensions (mm)

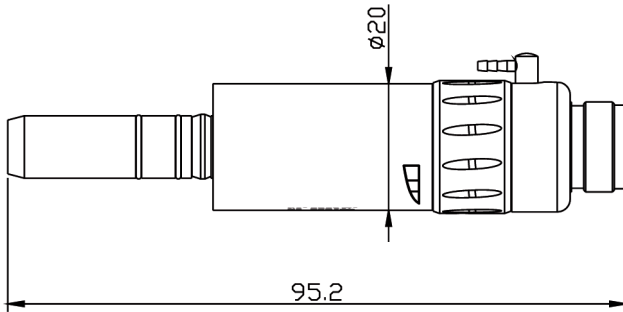

BORDEN TYPE WITH SPRAY

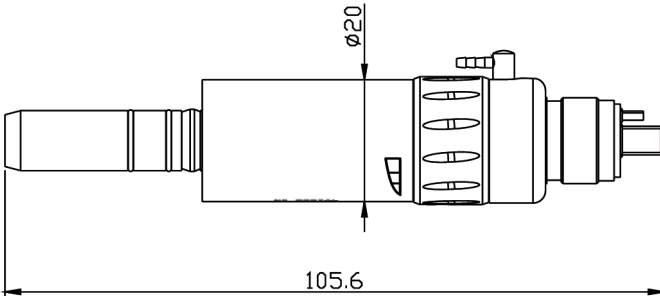

MIDWEST TYPE WITH SPRAY

OPERATION OF EQUIPMENT



Warning

It is indispensable that the driving air is dry, clean and uncontaminated. Dirty and moist air lead to premature wear of the bearings.



Warning

Handpieces must be used at a height of up to 1 meter from the ground.

For the handpiece to function well it is necessary to have a driving pressure of $275.79 \text{ kpa} = 40 \text{ psi} = 2.75 \text{ bar}$.

Terminal Coupling

Make sure that the instrument connection is compatible with the equipment (type Borden or type Midwest as figures (a) and (b)). Connect Air motors to equip terminal, thread the ring of the terminal turning it clockwise until it is fastened.

Before using it for the first time, follow the lubrication procedures.

fig. a



Type BORDEN

fig. b



Type MIDWEST

Coupling of Air motors with handpieces (Straight handpiece and Contra-Angle)

Attaching the Contra Angle or Straight Part in the coupling of Air motors (fig. c). To disengage by pressing, pull the handpiece.

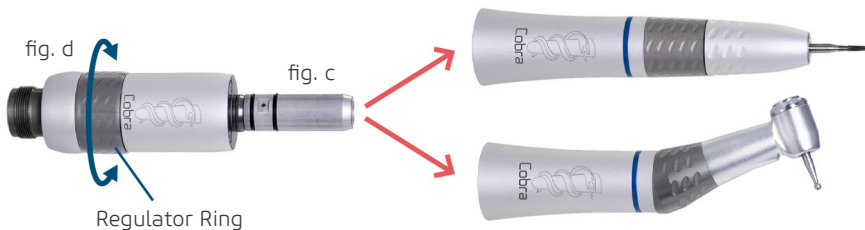

Adjusting speed and direction of rotation

To adjust the speed and direction of rotation, turn the regulator ring clockwise or counterclockwise as required (fig. d).

PRECAUTIONS, RESTRICTIONS AND WARNINGS

Recommendations for preserving the equipment

Your equipment has been designed and developed according to the standards of modern technology. Similarly to other kinds of equipment, it requires special care, which is many times neglected due to several reasons and circumstances. Therefore, here are some important reminders for your daily routine. Try to follow these simple rules, which will save you a lot of time and will avoid unnecessary expenses once they start making part of your working procedure.

Transportation, storage and operation

This equipment must be transported and stored observing the following directions:

- Avoid falls and impacts;
- Keep it dry, do not expose it to rain, water drops or wet floor;
- Keep it away from water and direct sunlight, and in its original wrapping;
- Don't move it over irregular surfaces, protect it from rain and observe the maximum stack quantity specified in the packaging;

Environmental condition for transportation or storage:

- Room temperature range for transportation or storage -12°C a +50°C.

Environmental operation condition:

- Room temperature range for functioning +10°C to +40°C.
- Recommended room temperature range +21°C to +26°C.
- Relative humidity range for functioning 30% to 75%.
- Atmospheric pressure range 700 hPa to 1060 hPa (525 mmHg to 795 mmHg).
- Operation altitude: ≤2000m.



Attention

The Equipment maintains its condition of safety and efficacy, provided that it is maintained (stored) as mentioned in this instruction of use. Thus, the equipment will not lose or alter its physical and dimensional features.

Sensibility to predictable environmental conditions in regular use conditions

- The equipment has been planned not to be sensitive to interference such as magnetic fields, external electrical factors, electrostatic discharge, pressure or variance of pressure, provided that the equipment is installed, maintained, clean, preserved, transported and operated as per this instruction for use.

Precautions and warnings “during the use” of equipment

- The equipment should only be operated by duly enabled and trained technicians (Dental Surgeons, Capacitated Professionals).
- Before the first use and/or after long interruptions from work such as vacations, clean and disinfect the equipment.
- If any maintenance should be required, only use services of the Alliage Authorized Technical Assistance.
- Owing to its delicate components, this handpiece must not be dropped or undergo impacts.
- Although this equipment has been planned in accordance with the standards of electromagnetic compatibility, it can, in very extreme conditions, cause interference with other equipment. Do not use this equipment together with other devices very sensitive to interference or with devices which create high electromagnetic disturbance.
- Do not expose the plastic parts to contact with chemical substances, use in the routines of dental treatment, such as: acids, mercury, acrylic liquids, amalgams, etc.

PRECAUTIONS, RESTRICTIONS AND WARNINGS

- The use of pneumatic or electric tools to perform any type of recording on handpieces, could lead to damage to the surface treatment of the product, causing the loss of warranty.

Manufacturer shall not be responsible for:

- Use of the equipment differing from that for which it is intended.
- Damages caused to the equipment, the professional and/or the patient by the incorrect installation and erroneous procedures of maintenance, differing from those described in these Instructions for use which come with the equipment or by the incorrect operation of it.

Precautions and warnings “after” the use of equipment

- Always maintain the equipment clean for the next operation.
- Do not modify any part of the equipment. Do not disconnect the cable or other connections without need.
- After using the equipment, clean and disinfect all the parts which may be in contact with the patient.

Precautions in case of alteration in the functioning of equipment



Warning

Do not use the equipment in conditions unsuitable for use.

- If the equipment has any abnormality, check if the problem is related to any item listed in the topic of unforeseen events (failures, causes and solutions). If it is not possible to resolve the problem, contact your representative (Alliage).

Precautions to be adopted against foreseeable or uncommon risks, related to the deactivation and abandoning of equipment

In order to avoid environmental contamination or undue use of the Equipment after it has become useless, it should be discarded in the suitable place (as per the local legislation of the country).

- Pay attention to the local legislation of the country for the conditions of installation and disposal of residue.

Precautions for the Reduction of the Environment Impact

Alliage S/A aims to achieve an environmental policy that encourages the environmentally conscious supply of medical products that continuously minimize environmental impact and are more environmentally friendly and human health friendly.

To keep a minimum impact on the environment, observe the following recommendations:

- After installation, forward the recyclable materials for the recycling process.
- During the life cycle of the equipment, turn it off when it is not being used.

The biomedical waste comprises nonhigh material susceptible to cause disease or house pathogenic organisms that must be stored in a yellow bag properly labeled with the symbol of biological hazard, or stored in a container resistant to perforation, tight and even collection and incineration.



The packaging consists of cardboard, plastic and expanded polystyrene (EPS) which are 100% recyclable materials.

Dimensions:

Main unit: 0,170 X 0,071 X 0,030 / MASS: About: 0,155 Kg.

EQUIPMENT REUSE

Additional procedures for reuse



Handpieces may only be serviced in the field at the points described in the user manual. If they need to be disassembled, they must be taken to the manufacturer.

The equipment can be reused in undetermined, i.e. unlimited, quantities, only needing to be cleaned, disinfected and Sterilization.

Cleaning and Disinfection

These processes should be used in the handpieces.

Uncouple the piece from the terminal part.

Do not use microabrasive material or steel wool when cleaning, or employ organic solvents or detergents which contain solvents such as ether, stain remover, etc.



For your protection, during the equipment cleaning and disinfection process, use PPE such as disposable gloves and goggles.

The cleaning and disinfection process must be performed at each patient change.

When starting the process, check for visible dirt, such as blood or saliva.

For cleaning use a clean, soft cloth moistened with mild soap and then dry with a clean, soft cloth or paper towel.

For the disinfection process of the Handpiece, use disinfectant detergent foam without alcohol that has active components based on didecyldimethylammonium chloride.

Apply the disinfectant detergent foam on the surface or on a clean cloth and spread it on the surface to be treated. Respect the antimicrobial contact time specified by the manufacturer.



Warning

Never submerge the instrument in a disinfection bath.

Never use product peracetic acid for cleaning, since it is corrosive.

Sterilization

Follow the appliance manufacturer's instructions.

They must be sterilized, handpieces and bur remover.

Sterilize only clean and lubricated Handpieces.

Clean, lubricate and remove excess oil from the instrument as indicated above, place it in surgical-grade paper packaging (not supplied with the product) and sterilize in a steam autoclave for one cycle.

135°C



Sterilization time minimum 30 minutes at 121 °C or minimum 3 minutes at 135 °C, and equivalent temperature and time parameters may be used within this range. Maximum sterilization temperature 135 °C.



Warning

Sterilize before 1st use, product do not provided sterilized.

Not valid or recommend to the sterilization by ethylene oxide.

Do not sterilize in an oven.

Before sterilization, connect it to the delivery unit and activate it for a few seconds to eliminate the excess of oil.

If the excess of oil is not eliminated, it may cause burnt residue in the bearing.

EQUIPMENT REUSE

Spray lubrication

To carry out the lubrication of your equipment, we recommend the use of the Lubs product. Lubrication must be carried out by the posterior hole of Air motors as illustrated in fig. (a). Firmly fit the oil applicator nozzle into the hole indicated in fig. (a) and apply the spray for 1 or 2 seconds (fig. b) by holding the vial in vertical position. Perform these operations (spray lubrication) with the regulating ring positioned clockwise and counterclockwise. Before of use, activate a handpiece during some seconds to eliminate the excess of oil. Cover the piece with absorbent paper to remove the excess of oil.

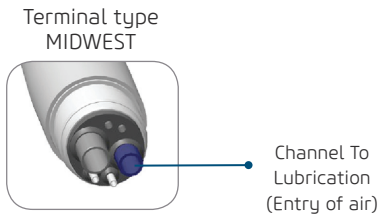
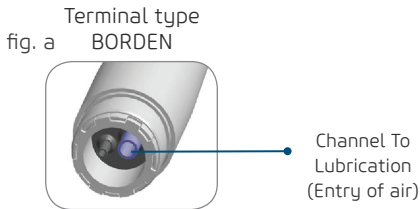

The lubricant doesn't follow the product.



Attention

Handpieces no submitted to process of sterilization should be lubricated at least twice a day.



Attention

The non-use of the lubricant will result In the loss of product warranty.

INSPECTION AND MAINTENANCE

Periodic Inspection

It is imperative that this equipment is regularly inspected to ensure operational safety and functional reliability.

The manufacturer is exempt from responsibility that the standard results do not conform in cases where the user does not carry out the inspection recommended by the manufacturer.

The inspection must be carried out, documented and maintained with the equipment by the user and is not part of the warranty of the same.

The table below gives a description of the main inspection items and recommended frequency.

Item	Inspection description	Recommended frequency
- Operating noise.	- Audibly, check the equipment for any abnormalities.	Daily
- Coupling.	- Make sure that the Air motors is well fixed to the Delivery Unit terminal.	Daily
- Water leak.	- Check if the spray holes are leaking water.	Monthly
- Clogging.	- Check that the spray holes are not blocked.	Monthly

If problems are detected during the inspection, perform the procedures described in the Corrective Maintenance item.

Preventive Maintenance

The equipment must be submitted to preventive maintenance with a maximum period of 3 years. For protecting your equipment, look for a Alliage' technical assistance for periodic reviews as preventive maintenances.

Corrective Maintenance

Alliage states that the supplying of the circuits' diagram, Part lists or any other information that permits the technical assistance by the user, can be requested, since previously agreed between the buyer and Alliage.

Attention

In case of the equipment presents any abnormality; check if the problem is related to some of the listed items under the item Unpredictable (situation, cause and solution).

If it's not possible to solve the problem, shutdown the equipment and demand the presence of a Alliage technician from the nearest resale, or ask through the Attendance Service Alliage: + 55 (16) 3512-1212.

INSPECTION AND MAINTENANCE

Maintenance of the BORDEN Type Lining

Insert a screwdriver of 1.2mm in the face of the lining as per (fig. a), using it as a lever until removing it from the hole.

Remove the damaged lining (fig. b).

Place the new lining in the hole leaving the holes aligned, and with a screwdriver push the lining carefully downwards (fig. c).

Spray Regulation

Spray cooling requires at least 50 cm³/min of water. An insufficient amount of water can lead to overheating of the tooth. With the terminal register open and the instrument working (with Bur), slowly close the register until the desired spray is achieved.

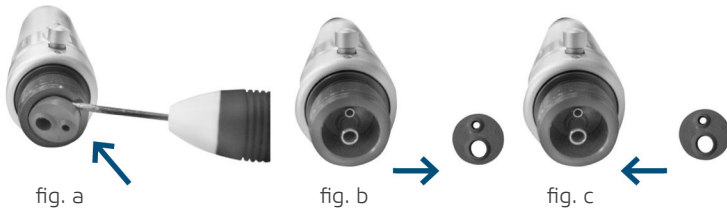

Maintenance of the MIDWEST Type Lining

Use the same procedure as the BORDEN type.

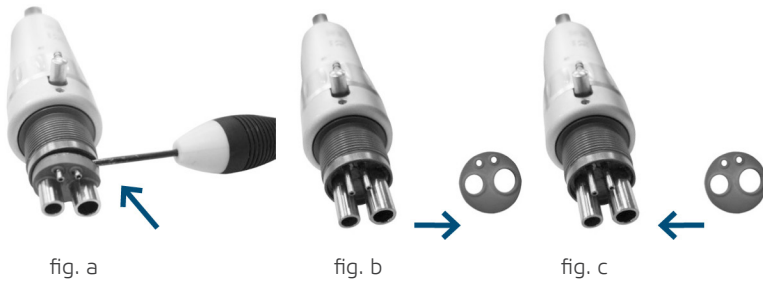

INSPECTION AND MAINTENANCE

Maintenance of O-Ring

Change:

Insert a screwdriver of 1.2mm in the channel of the O-ring, moving it outwards - fig. (a) and (b). In order to fasten the new ring, execute the opposite process without the screwdriver (fig. c).

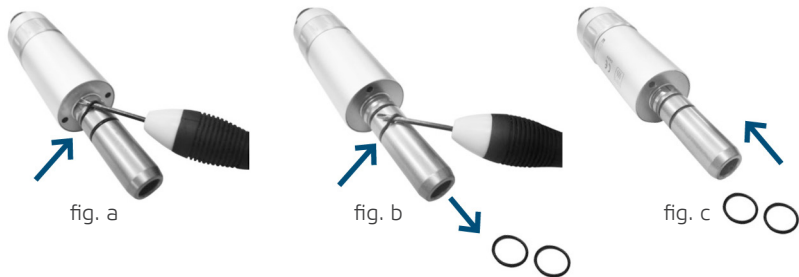

INSPECTION AND MAINTENANCE



Attention

Upon coming across any problem in operation, follow the instructions below to check and repair the problem, and/or get in touch with your representative. Handpieces may be serviced in the field only at the points described below. If they need to be disassembled, they must be taken to the manufacturer.

Problem	Probable cause	Solution
-The Air motors does not function.	-The control ring is in the intermediary position between the counterclockwise and clockwise directions of speed. -Lack of lubrication or inadequate lubrication. -The connection of the instrument / terminal is loose. - Bearing damaged.	-Turn the control ring in a clockwise or counterclockwise direction. -Lubricate as per the indications. -Tighten the connection. -Send to the authorized service.
-Insufficient speed.	-Lack of air or low air pressure. -Lack of lubrication or Inadequate lubrication.	-Check the air pressure in the network. -Lubricate as per the indications.
-Failure and noise in the functioning.	-Air leakage. -Lack of lubrication.	-Examine the hoses and connections. -Lubricate as indicated.

EQUIPMENT'S WARRANTY

This equipment is covered by the warranty periods, terms and conditions contained in the Warranty Certificate that comes with the product.

FINAL CONSIDERATIONS

Among the care you have to take with your equipment, the most important is regarding of the spare parts replacement.

To ensure the lifetime of your device, only replace original spare parts from Alliage. They have the assurance of the standards and technical specifications required by the Alliage representative.

We call your attention to our authorized resellers' chain. Only this chain will keep your equipment constantly new, because it has trained technical assistant and specific tools for the correct maintenance of your device.

Whenever you need, demand the presence of a Alliage' technician from the nearest resale, or ask through the Attendance Service Alliage: + 55 (16) 3512-1212.

NUM. REG. ANVISA: 10069210073

D700

www.d700.com.br

uma marca
alliage